

## PRODUKTINFORMATION



**HÄMTFAX**  
08-580 941 14



**FAX ON DEMAND**  
+46 8 580 941 14



**INTERNET**  
<http://www.elfa.se>

**TEKNISK INFORMATION 020-75 80 20    ORDERTEL 020-75 80 00    ORDERFAX 020-75 80 10**

**TECHNICAL INFORMATION +46 8 580 941 15    ORDERPHONE +46 8 580 941 01    ORDERFAX +46 8 580 941 11**

— Vi reserverar oss mot fel samt förbehåller oss rätten till ändringar utan föregående meddelande —

**ELFA artikelnr.**

**72-007-69 BT152-400R Tyristor**

**72-007-77 BT152-800R Tyristor**

**72-019-40 BT152-600R Tyristor**

**Antal sidor: 07**

# Thyristors

# BT152 series

## GENERAL DESCRIPTION

Glass passivated thyristors in a plastic envelope, intended for use in applications requiring high bidirectional blocking voltage capability and high thermal cycling performance. Typical applications include motor control, industrial and domestic lighting, heating and static switching.

## QUICK REFERENCE DATA

SYMBOL	PARAMETER	MAX.	MAX.	MAX.	UNIT
$V_{DRM}$ , $V_{RRM}$	Repetitive peak off-state voltages	<b>400R</b> 450	<b>600R</b> 650	<b>800R</b> 800	V
$I_{T(AV)}$	Average on-state current	13	13	13	A
$I_{T(RMS)}$	RMS on-state current	20	20	20	A
$I_{TSM}$	Non-repetitive peak on-state current	200	200	200	A

## PINNING - TO220AB

PIN	DESCRIPTION
1	cathode
2	anode
3	gate
tab	anode

## PIN CONFIGURATION

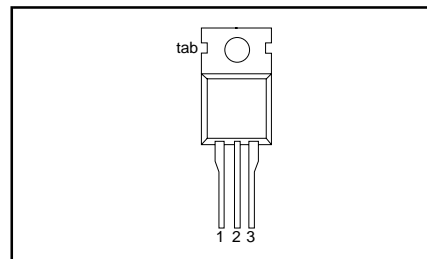

## SYMBOL

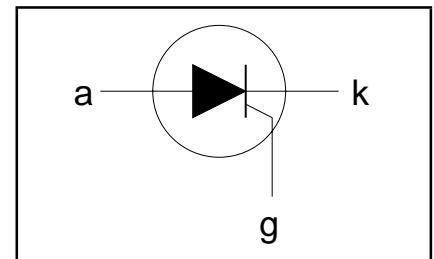

## LIMITING VALUES

Limiting values in accordance with the Absolute Maximum System (IEC 134).

SYMBOL	PARAMETER	CONDITIONS	MIN.	MAX.			UNIT
$V_{DRM}$	Repetitive peak off-state voltages		-	<b>-400R</b> 450 <sup>1</sup>	<b>-600R</b> 650 <sup>1</sup>	<b>-800R</b> 800	V
$I_{T(AV)}$	Average on-state current	half sine wave; $T_{mb} \leq 103\text{ }^\circ\text{C}$	-	13			A
$I_{T(RMS)}$	RMS on-state current	all conduction angles	-	20			A
$I_{TSM}$	Non-repetitive peak on-state current	half sine wave; $T_j = 25\text{ }^\circ\text{C}$ prior to surge	-	200			A
		$t = 10\text{ ms}$	-	220			A
		$t = 8.3\text{ ms}$	-	200			A <sup>2</sup> s
$I^2t$	$I^2t$ for fusing	$t = 10\text{ ms}$	-	200			A $\mu$ s
$di_T/dt$	Repetitive rate of rise of on-state current after triggering	$I_{TM} = 50\text{ A}$ ; $I_G = 0.2\text{ A}$ ; $di_G/dt = 0.2\text{ A}/\mu\text{s}$	-	200			
$I_{GM}$	Peak gate current		-	5			A
$V_{GM}$	Peak gate voltage		-	5			V
$V_{RGM}$	Peak reverse gate voltage		-	5			V
$P_{GM}$	Peak gate power		-	20			W
$P_{G(AV)}$	Average gate power	over any 20 ms period	-	0.5			W
$T_{stg}$	Storage temperature		-40	150			$^\circ\text{C}$
$T_j$	Operating junction temperature		-	125			$^\circ\text{C}$

<sup>1</sup> Although not recommended, off-state voltages up to 800V may be applied without damage, but the thyristor may switch to the on-state. The rate of rise of current should not exceed 15 A/ $\mu$ s.

## Thyristors

## BT152 series

**THERMAL RESISTANCES**

SYMBOL	PARAMETER	CONDITIONS	MIN.	TYP.	MAX.	UNIT
$R_{th\ j-mb}$	Thermal resistance junction to mounting base	in free air	-	-	1.1	K/W
$R_{th\ j-a}$	Thermal resistance junction to ambient		-	60	-	K/W

**STATIC CHARACTERISTICS** $T_j = 25\text{ °C}$  unless otherwise stated

SYMBOL	PARAMETER	CONDITIONS	MIN.	TYP.	MAX.	UNIT
$I_{GT}$	Gate trigger current	$V_D = 12\text{ V}; I_T = 0.1\text{ A}$	-	3	32	mA
$I_L$	Latching current	$V_D = 12\text{ V}; I_{GT} = 0.1\text{ A}$	-	25	80	mA
$I_H$	Holding current	$V_D = 12\text{ V}; I_{GT} = 0.1\text{ A}$	-	15	60	mA
$V_T$	On-state voltage	$I_T = 40\text{ A}$	-	1.4	1.75	V
$V_{GT}$	Gate trigger voltage	$V_D = 12\text{ V}; I_T = 0.1\text{ A}$	-	0.6	1.5	V
$I_D, I_R$	Off-state leakage current	$V_D = V_{DRM(max)}; I_T = 0.1\text{ A}; T_j = 125\text{ °C}$	0.25	0.4	-	V
		$V_D = V_{DRM(max)}; V_R = V_{RRM(max)}; T_j = 125\text{ °C}$	-	0.2	1.0	mA

**DYNAMIC CHARACTERISTICS** $T_j = 25\text{ °C}$  unless otherwise stated

SYMBOL	PARAMETER	CONDITIONS	MIN.	TYP.	MAX.	UNIT
$dV_D/dt$	Critical rate of rise of off-state voltage	$V_{DM} = 67\% V_{DRM(max)}; T_j = 125\text{ °C};$ exponential waveform gate open circuit	200	300	-	V/ $\mu$ s
$t_{gt}$	Gate controlled turn-on time	$V_D = V_{DRM(max)}; I_G = 0.1\text{ A}; dI_G/dt = 5\text{ A}/\mu\text{s};$ $I_{TM} = 40\text{ A}$	-	2	-	$\mu$ s
$t_q$	Circuit commutated turn-off time	$V_D = 67\% V_{DRM(max)}; T_j = 125\text{ °C};$ $I_{TM} = 50\text{ A}; V_R = 25\text{ V}; dI_{TM}/dt = 30\text{ A}/\mu\text{s};$ $dV_D/dt = 50\text{ V}/\mu\text{s}; R_{GK} = 100\ \Omega$	-	70	-	$\mu$ s

Thyristors

BT152 series

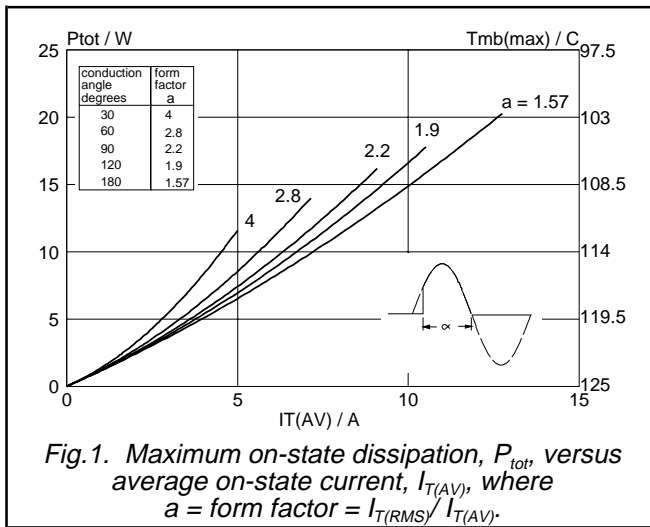

Fig. 1. Maximum on-state dissipation,  $P_{tot}$ , versus average on-state current,  $I_{T(AV)}$ , where  $a = \text{form factor} = I_{T(RMS)} / I_{T(AV)}$ .

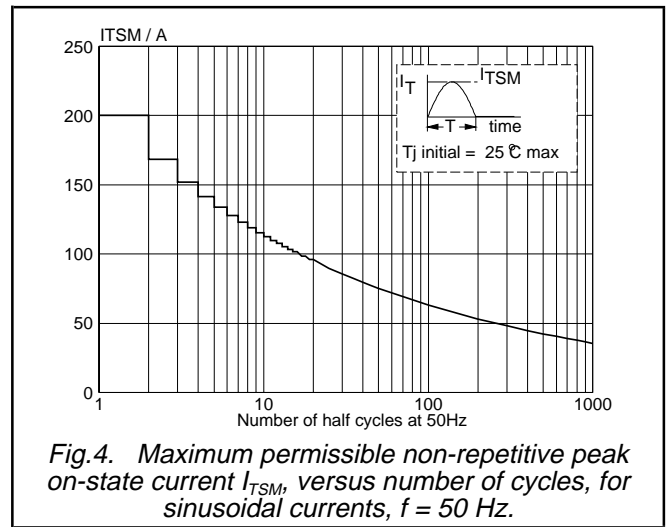

Fig. 4. Maximum permissible non-repetitive peak on-state current  $I_{TSM}$ , versus number of cycles, for sinusoidal currents,  $f = 50 \text{ Hz}$ .

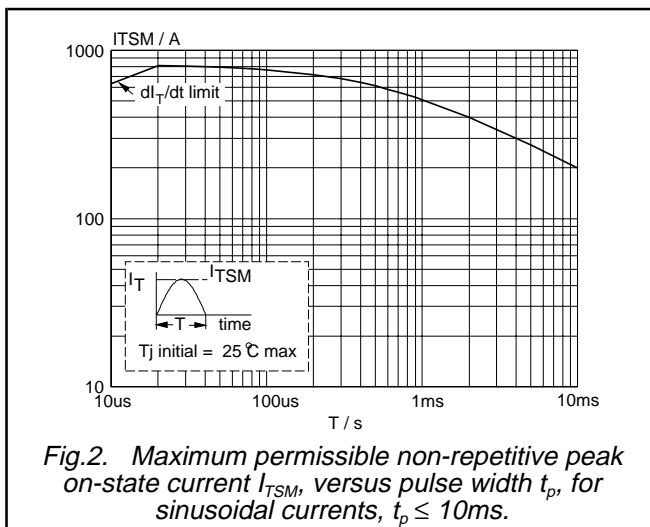

Fig. 2. Maximum permissible non-repetitive peak on-state current  $I_{TSM}$ , versus pulse width  $t_p$ , for sinusoidal currents,  $t_p \leq 10 \text{ ms}$ .

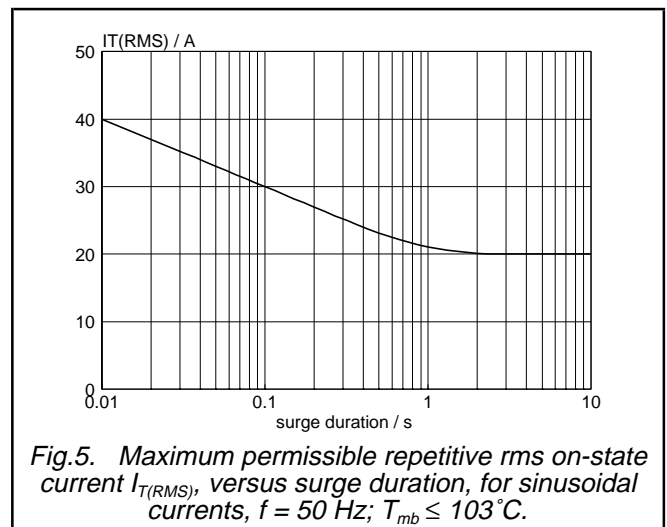

Fig. 5. Maximum permissible repetitive rms on-state current  $I_{T(RMS)}$ , versus surge duration, for sinusoidal currents,  $f = 50 \text{ Hz}$ ;  $T_{mb} \leq 103^\circ \text{C}$ .

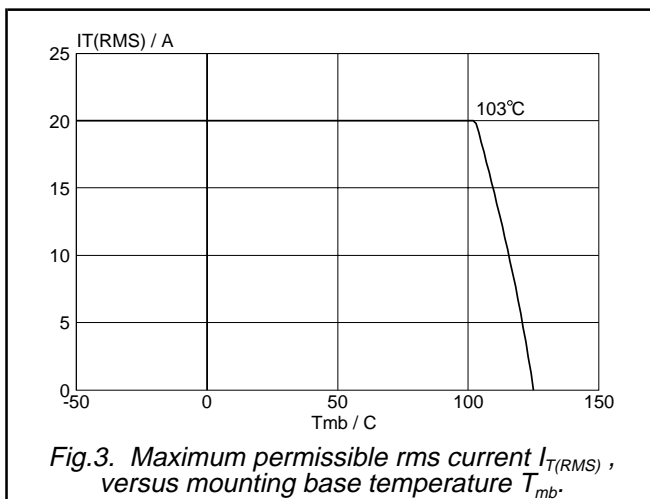

Fig. 3. Maximum permissible rms current  $I_{T(RMS)}$ , versus mounting base temperature  $T_{mb}$ .

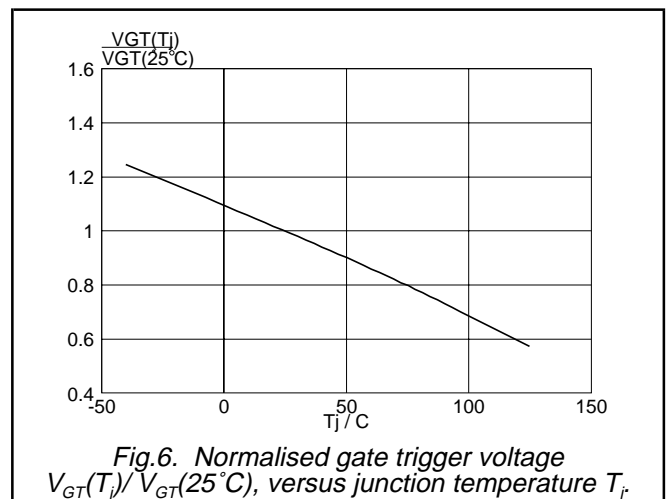
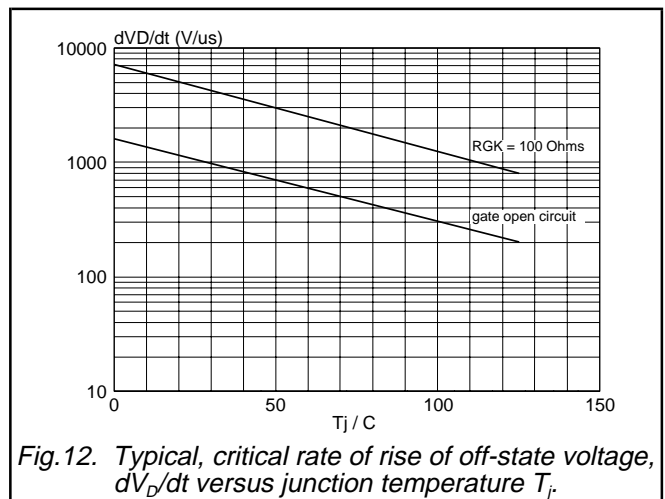
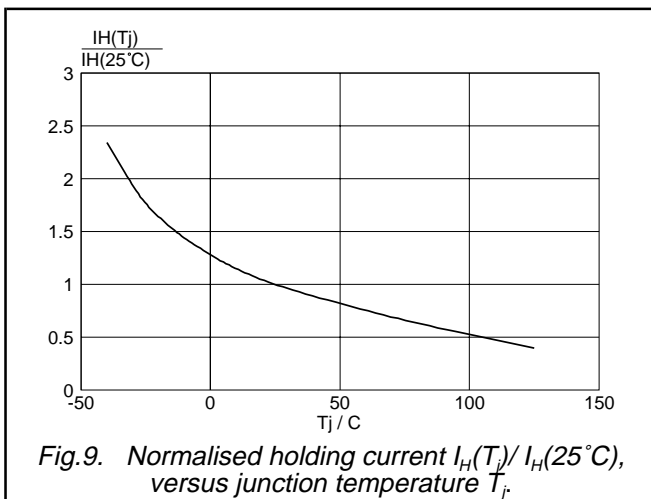
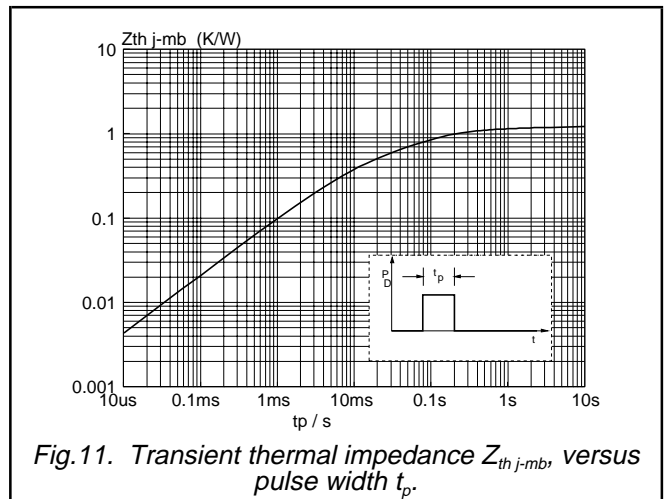
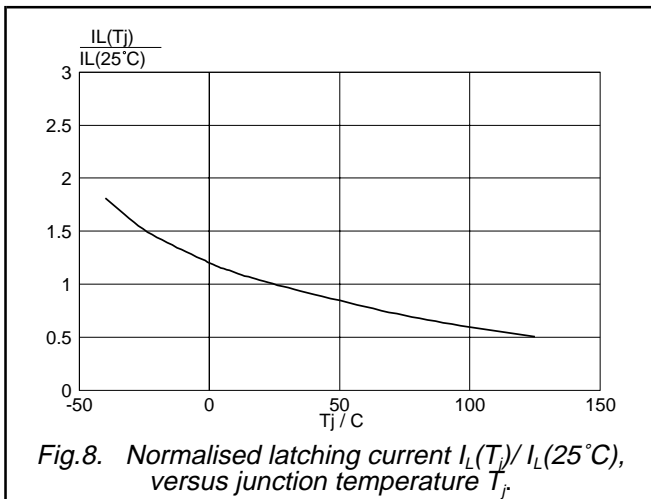
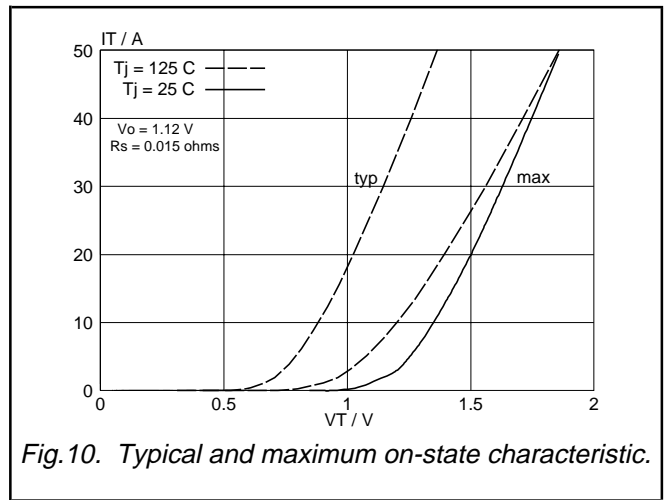
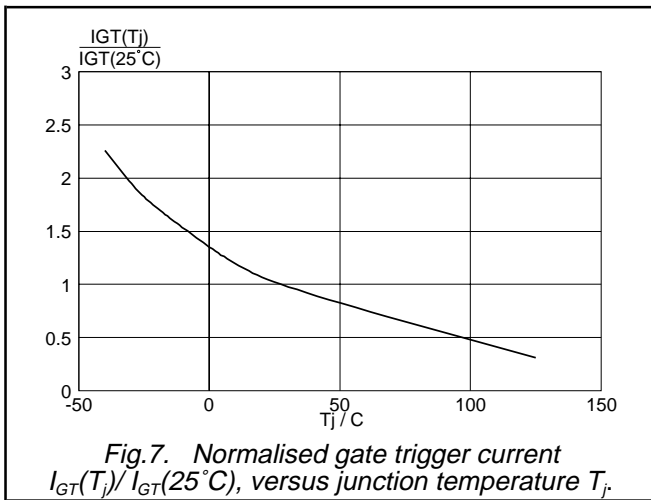

Fig. 6. Normalised gate trigger voltage  $V_{GT}(T_j) / V_{GT}(25^\circ \text{C})$ , versus junction temperature  $T_j$ .

Thyristors

BT152 series



Thyristors

BT152 series

**MECHANICAL DATA**

*Dimensions in mm*

*Net Mass: 2 g*

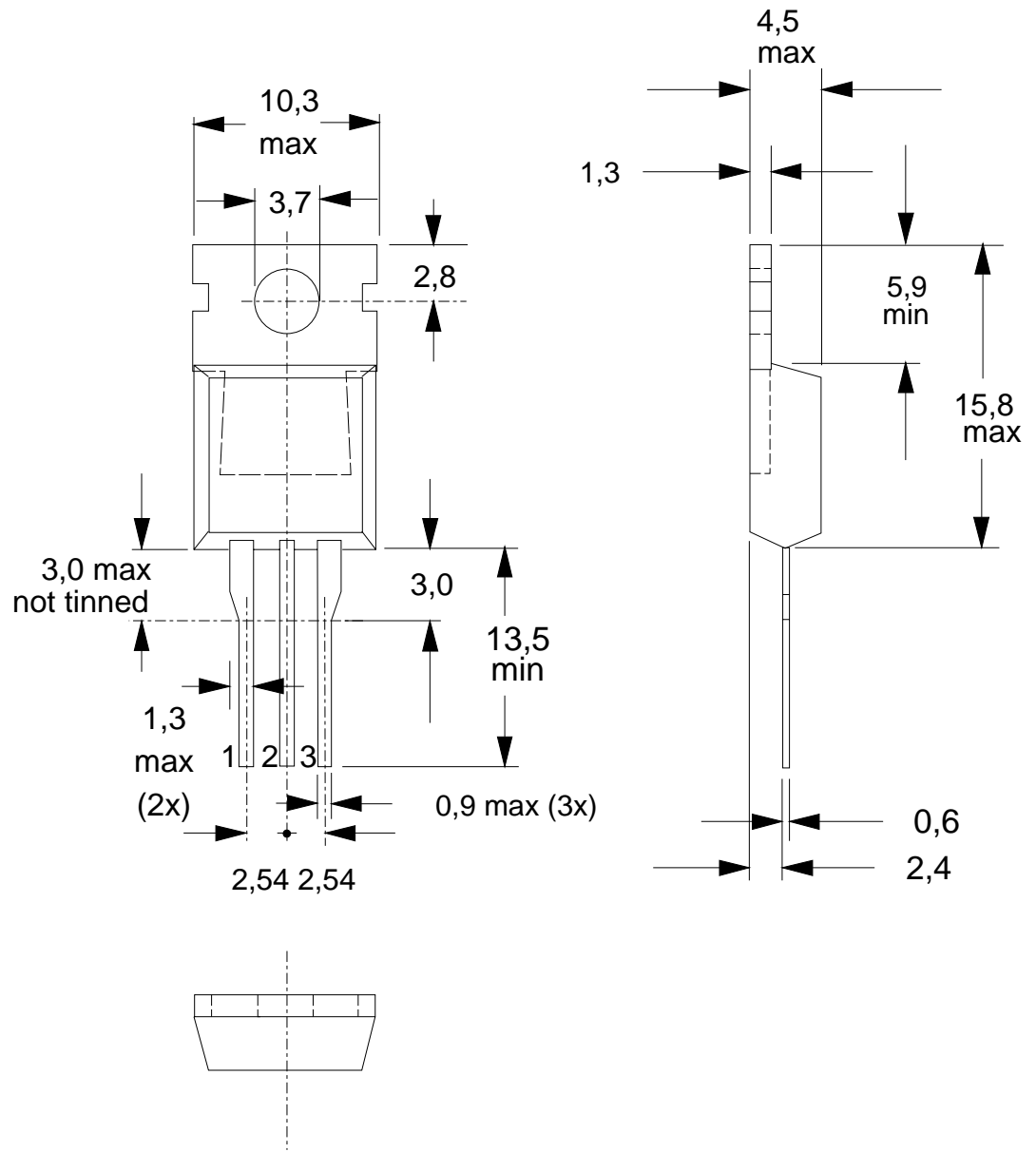

Fig.13. TO220AB; pin 2 connected to mounting base.

**Notes**

1. Refer to mounting instructions for TO220 envelopes.
2. Epoxy meets UL94 V0 at 1/8".

## Thyristors

## BT152 series

**DEFINITIONS**

<b>Data sheet status</b>	
Objective specification	This data sheet contains target or goal specifications for product development.
Preliminary specification	This data sheet contains preliminary data; supplementary data may be published later.
Product specification	This data sheet contains final product specifications.
<b>Limiting values</b>	
Limiting values are given in accordance with the Absolute Maximum Rating System (IEC 134). Stress above one or more of the limiting values may cause permanent damage to the device. These are stress ratings only and operation of the device at these or at any other conditions above those given in the Characteristics sections of this specification is not implied. Exposure to limiting values for extended periods may affect device reliability.	
<b>Application information</b>	
Where application information is given, it is advisory and does not form part of the specification.	
© Philips Electronics N.V. 1997	
All rights are reserved. Reproduction in whole or in part is prohibited without the prior written consent of the copyright owner.	
The information presented in this document does not form part of any quotation or contract, it is believed to be accurate and reliable and may be changed without notice. No liability will be accepted by the publisher for any consequence of its use. Publication thereof does not convey nor imply any license under patent or other industrial or intellectual property rights.	

**LIFE SUPPORT APPLICATIONS**

These products are not designed for use in life support appliances, devices or systems where malfunction of these products can be reasonably expected to result in personal injury. Philips customers using or selling these products for use in such applications do so at their own risk and agree to fully indemnify Philips for any damages resulting from such improper use or sale.